



PRODUCT DEFINITION

This Advertisim product includes in one device the screen and all the electronics components. It is mounted with a semi-embedded bracket, but we can add the ADV MI 10 (10" stainless frame) product to easily convert it in a surface screen.

The surface mount allows you to do the less modification possible in the lift cabin where the screen will be installed. The semi semi-embedded assembly mode is compatible with the Advertisim TCU 10E, in this way you can switch between both products easily.

This model includes in a native way connectivity to controllers with connection type CAN and optocoupled binary inputs. For controllers with other type of connections we can add the ADV EXT V3 product, which is an external device that includes CAN, 485 and binary inputs.

DATASHEET (TECHNICAL CHARACTERISTICS)

Screen size: 10.1"
 Active area 216.96 x 135.6mm
 16.2M colors
 Brightness: 350 Cd/m2
 Cortex A7 Dual Core processor
 3G miniPCle modem (according to model)
 FullHD 1080p
 HDMI output
 VGA output
 USB port x 2
 Ethernet connector x1
 DDR3 RAM 1Gb
 8Gb internal storage
 Audio out
 WIFI IEEE802.11fgn
 Ethernet CAT5e, CAT6, CAT7
 CAN L / H inputs
 Optocoupled binary inputs x 2
 Accelerometer and magnetometer
 Power consumption: 12W
 Temperature range: 0° - 40°

COMPONENTS LIST

- All in one 10E device
- 12V 2A Power supply (Only in AIO 10E 3G WIFI ALM and AIO 10E WIFI ALM models)
- WIFI antenna
- 3G antenna and SIM card (according to model)
- Installation die
- Installation manual

RELATED PRODUCTS

Models with 220V 2A AC/DC external power adapter

AIO 10E 3G WIFI ALM
AIO 10E WIFI ALM









Models with 12V feed direct cable

AIO 10E 3G WIFI CAB
AIO 10E WIFI CAB

Add-ons

ADV MI 10
ADV EXT V3

SERVICES AND APPLICATIONS

 Connection to controller	 High Definition	 Video player
 Accelerometer	 Voice synthesis for floor info	 Customizable
 10" screen	 Easy installation	

INSTALLATION DIAGRAM

1. Place and mark the edges and drills of the die.



2. Cut on the marks.

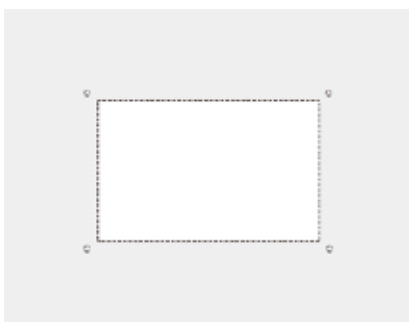

3. Place in the top of the car the 3G antenna and the power supply and pass the cables.

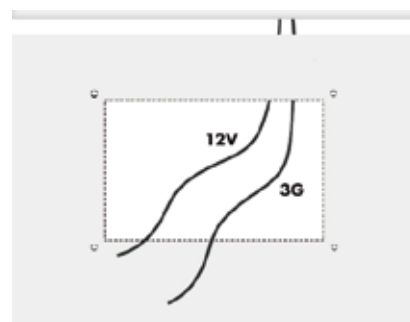

4. Connect to the controller.

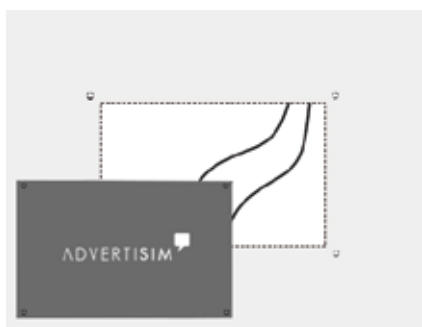

5. Place the screen and screw the bolts.



6. Connect the power supply or the 12V cable.

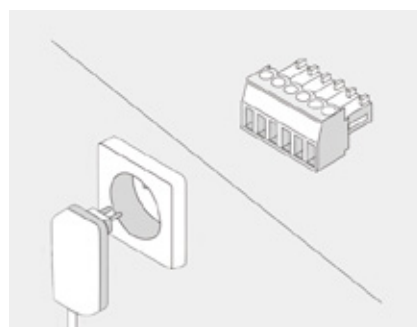

DRAWINGS AND DIMENSIONS

1. Installation die

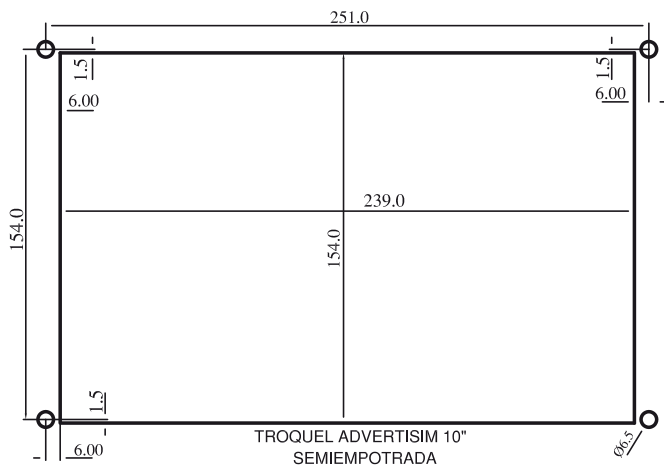

2. ADV MI 10

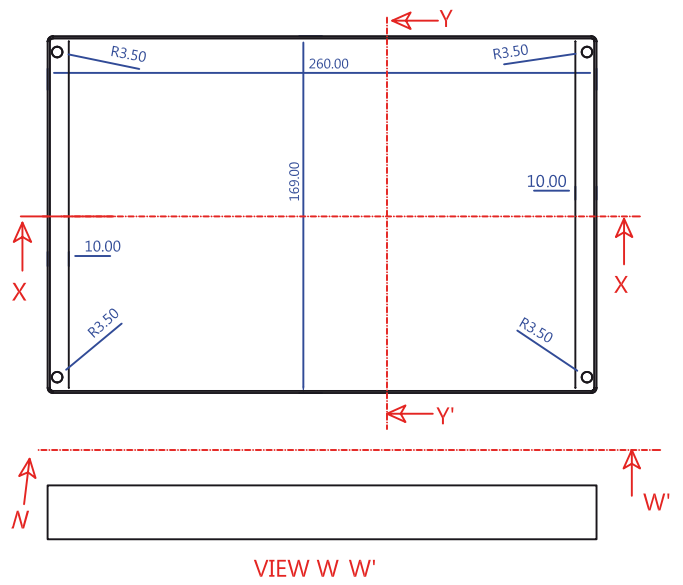

3. 10" protective glass

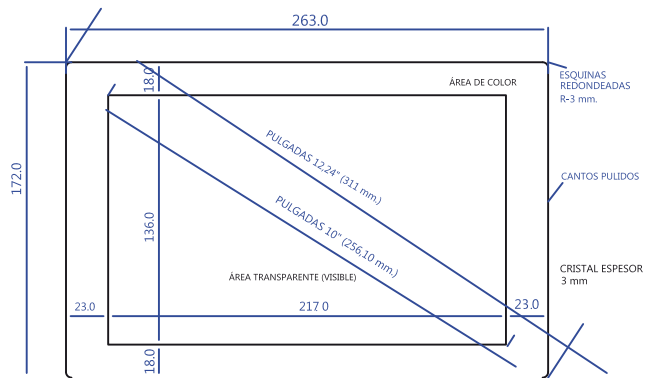

4. Full device

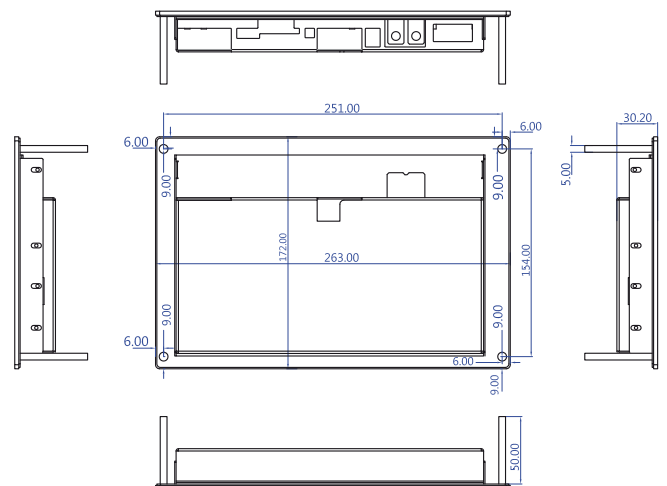

CONNECTORS

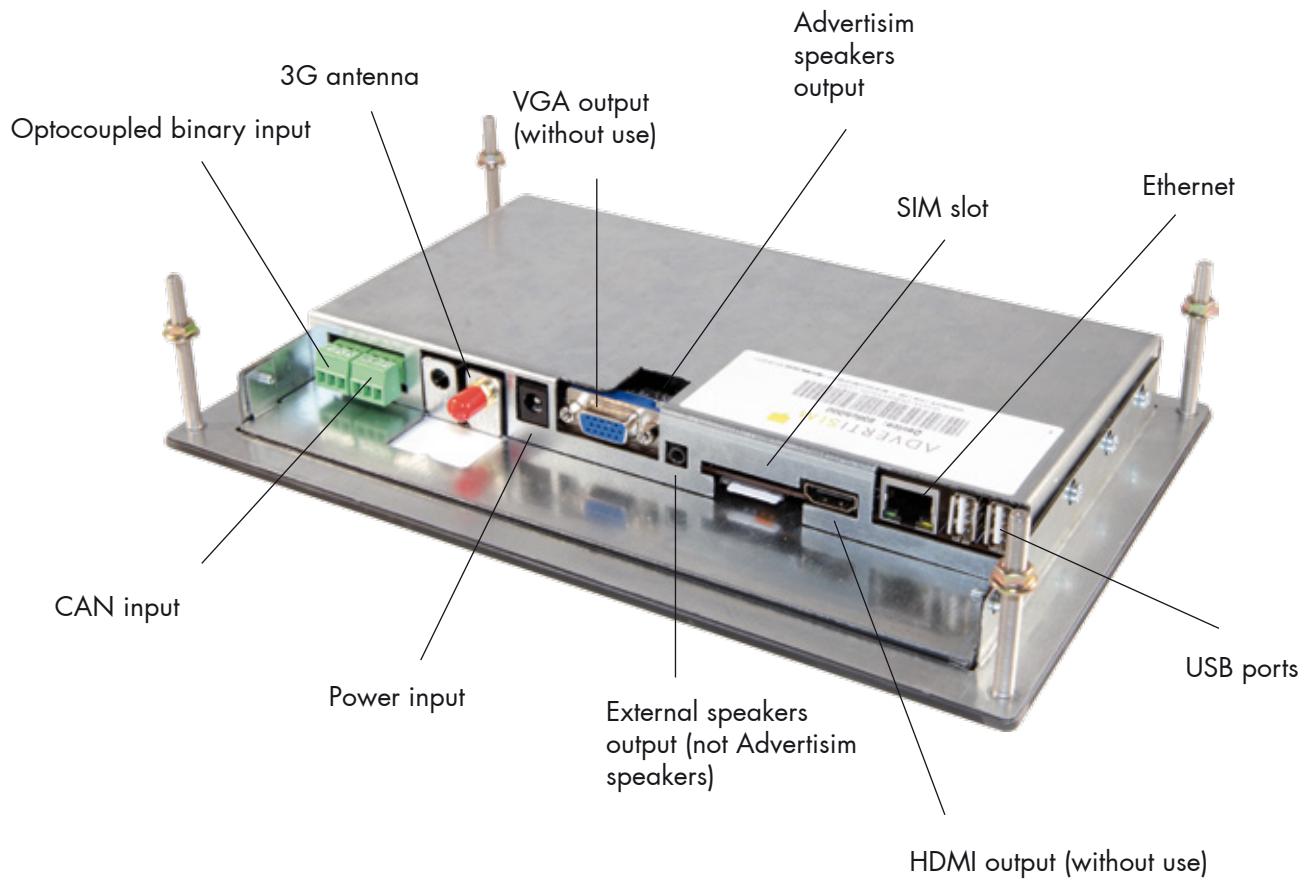



DEFINICIÓN DE PRODUCTO

Producto Advertisim compacto que incluye en el mismo dispositivo pantalla y electrónica. El soporte base es de tipo semiempotrado, pero es fácilmente convertible a soporte de tipo superficie simplemente añadiendo el producto ADV MI 10 (marco inox 10").

El montaje del **tipo superficie** evita hacer mecanizados en la cabina o botonera donde se vaya a instalar el producto. Para más información consultar el manual de instalación. El montaje de **tipo semiempotrado** es compatible con el producto TCU 10E, de forma que se permite rápidamente una sustitución entre ambos productos.

Este modelo solo incluye de forma nativa conexión a maniobra de tipo CAN y 2 entradas binarias optoacopladas, para maniobras con otro tipo de conexión es posible hacerlo a través del producto ADV EXT V3 (placa de conexión binaria, CAN y 485 externa).

DATASHEET (CARACTERÍSTICAS TÉCNICAS)

Tamaño pantalla: 10,1"
 Área activa 216.96 x 135.6mm
 16,2M colores
 350 Cd/m2 luminosidad
 Procesador Cortex A7 Dual Core
 Modem 3G miniPCIe (según modelo)
 FullHD 1080p
 Salida HDMI
 Salida VGA
 Puerto USB x 2
 Conector Ethernet x1
 DDR3 RAM 1Gb
 Almacenamiento interno 8Gb
 Salida audio
 WIFI IEEE802.11fgn
 Ethernet CAT5e, CAT6, CAT7
 Entradas CAN L/H
 Entrada Binaria Optoacoplada x 2
 Acelerómetro y magnetómetro
 Consumo eléctrico: 12W
 Rango de temperaturas: 0° - 40°

LISTADO DE COMPONENTES

- Dispositivo Advertisim All in one 10E
- Alimentador 12V 2A (solo en modelos AIO 10E 3G WIFI ALM y AIO 10E WIFI ALM)
- Antena WIFI
- Antena 3G y tarjeta SIM (según modelo)
- Troquel para instalación
- Manual de instalación

PRODUCTOS RELACIONADOS

Modelos con alimentación a través de transformador externo AC/DC 220V 2A

AIO 10E 3G WIFI ALM
AIO 10E WIFI ALM

Modelos con alimentación a través de cable directo a 12V

AIO 10E 3G WIFI CAB
AIO 10E WIFI CAB

Complementos

ADV MI 10
ADV EXT V3

SERVICIOS Y APLICACIONES



Conexión a maniobra



Visualización en alta calidad



Reproducción de vídeo



Acelerómetro



Síntesis de planta



Personalizable



Pantalla 10"



Fácil instalación

DIAGRAMA DE INSTALACIÓN

1. Colocar y marcar el troquel



2. Hacer el recorte

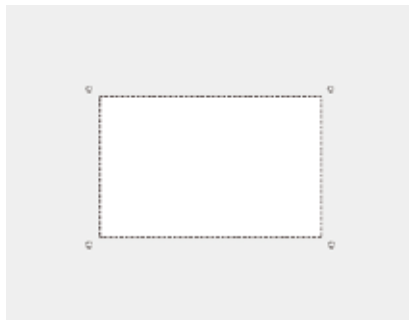

3. En el techo, colocar alimentador y antena y pasar los cables

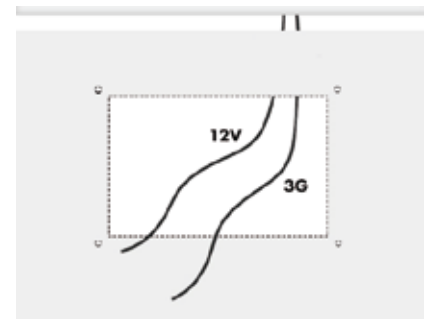

4. Conectar maniobra

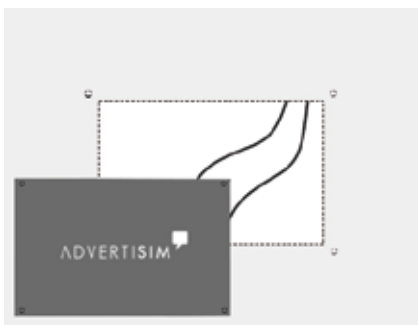

5. Colocar pantalla y atornillar



6. Conectar el alimentador o el cable 12V

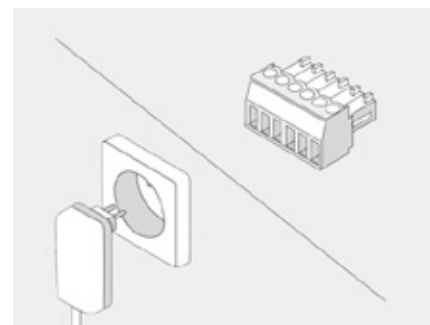

PLANOS Y COTAS

1. Troquel

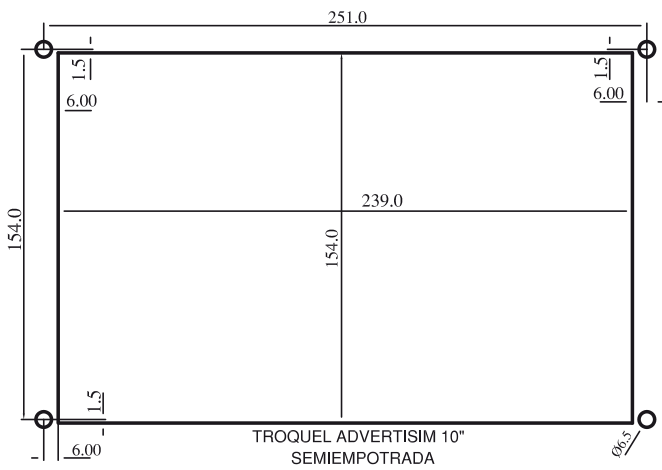

2. ADV MI 10 (Marco inox para montaje superficie)

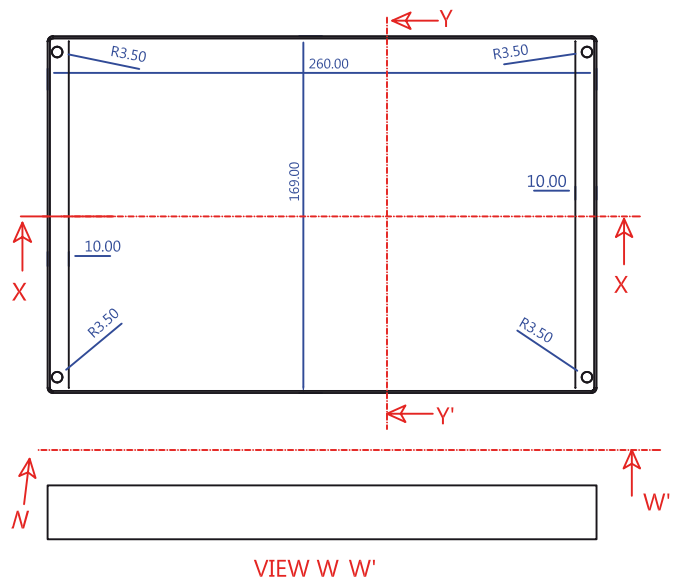

3. Cristal 10"

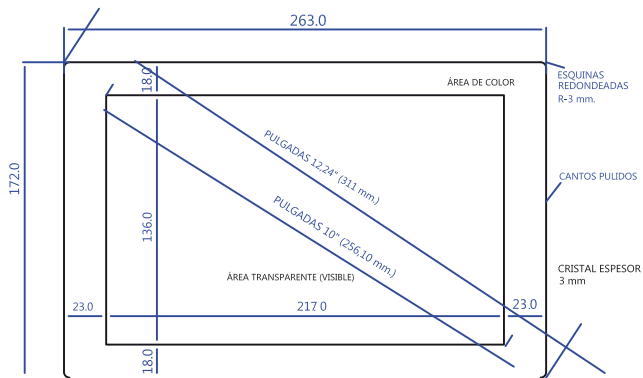

4. Producto completo

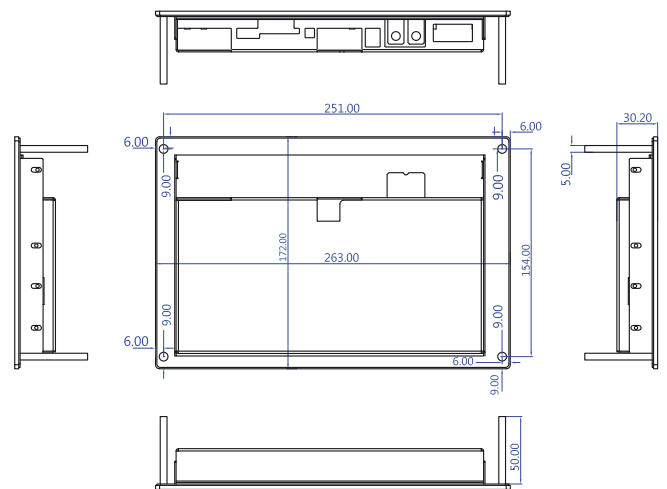

CONECTORES

